

Токарный патрон, 3-х кулачковый

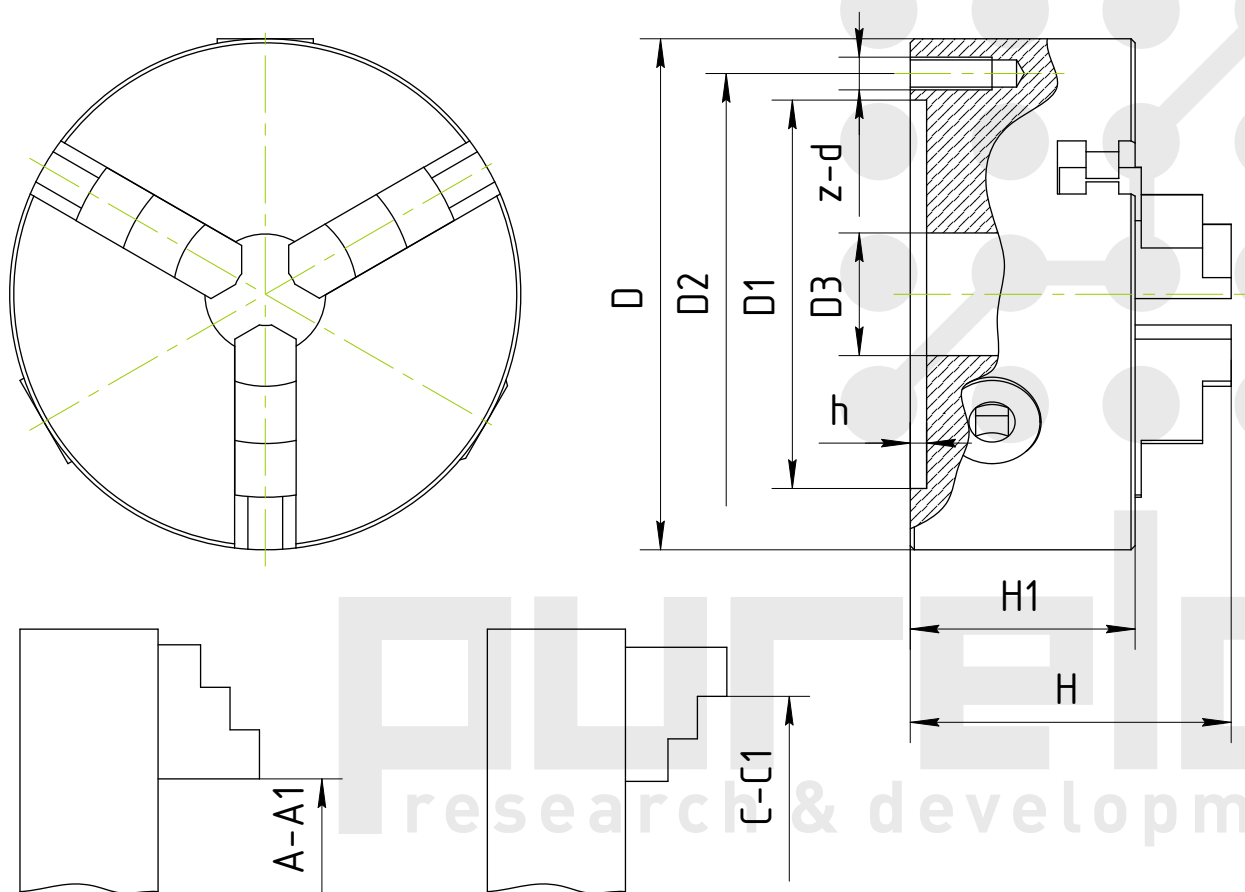

Типоразмер, D	D1	D2	D3	H	H1	h	z-d	Tmax, Hm	RPM, об/мин	A-A1	C-C1
80	55	66	16	66	50	3.5	3-M6	40	4000	2-22	22-63
100	72	84	22	74.5	55	3.5	3-M8	60	3500	2-30	30-80
125	95	108	30	85	58	4	3-M8	100	3000	2.5-40	38-110
160	130	142	45	95	65	5	3-M8	160	2500	3-55	55-145
160A	130	142	40	109	65	5	3-M8	160	2500	3-55	55-145
200	165	180	65	109	75	5	3-M10	250	2000	4-85	65-200
200A	165	180	65	122	75	5	3-M10	250	2000	4-85	65-200
250	206	226	80	120	80	5	3-M12	320	1600	6-110	90-250
250A	206	226	80	133	80	5	3-M12	320	1600	6-110	90-250
315	260	285	100	142.5	90	6	3-M16	400	1200	10-140	100-315
315A	260	285	100	155.5	90	6	3-M16	400	1200	10-140	100-315
400	340	368	130	155.5	100	6	3-M16	500	1000	15-210	120-400
400A	340	368	130	170.5	100	6	3-M16	500	1000	15-210	120-400
500	440	465	200	176	115	6	3-M16	500	1000	25-280	150-500
500A	440	465	200	203	115	6	3-M16	630	800	25-280	150-500
630A	560	595	260	218	130	8	3-M16	800	600	50-350	170-630

Tmax – максимальный крутящий момент

RPM – максимальное количество оборотов в минуту

Токарный патрон, 4-х кулачковый

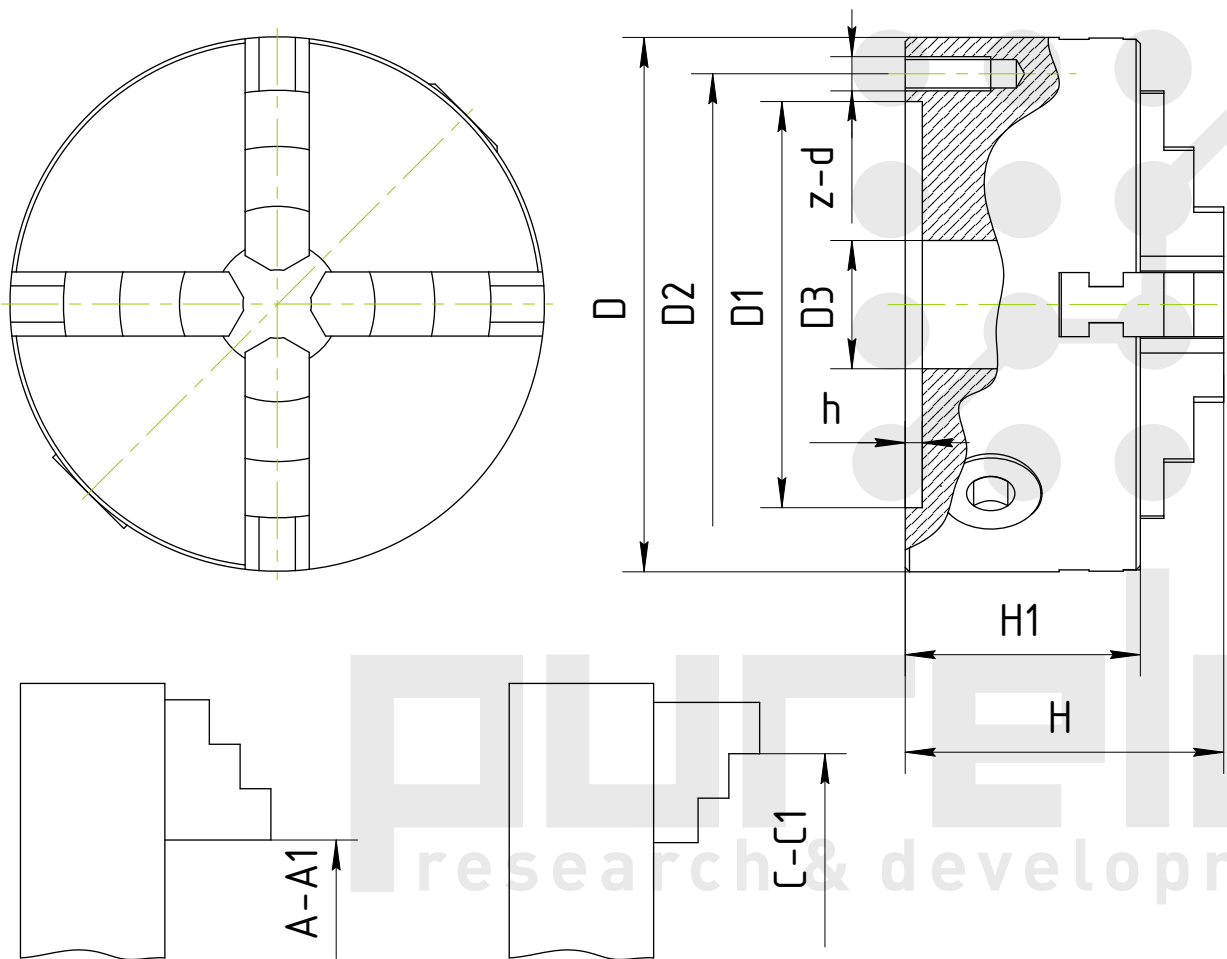

Типоразмер, D	D1	D2	D3	H	H1	h	z-d	Tmax, Hm	RPM, об/мин	A-A1	C-C1
80	55	66	16	66	50	3.5	3-M6	40	4000	2-22	22-63
100	72	84	22	74.5	55	3.5	3-M8	60	3500	2-30	30-80
125	95	108	30	85	58	4	3-M8	100	3000	2.5-40	38-110
130	100	115	30	85	60	4	3-M8	100	3000	2.5-40	38-110
160	130	142	45	95	65	5	3-M8	160	2500	3-55	55-145
160A	130	142	40	109	65	5	3-M8	160	2500	3-55	55-145
200	165	180	65	109	75	5	3-M10	250	2000	4-85	65-200
200A	165	180	65	122	75	5	3-M10	250	2000	4-85	65-200
250	206	226	80	120	80	5	3-M12	320	1600	6-110	90-250
250A	206	226	80	133	80	5	3-M12	320	1600	6-110	90-250
315	260	285	100	142.5	90	6	3-M16	400	1200	10-140	100-315
315A	260	285	100	155.5	90	6	3-M16	400	1200	10-140	100-315
320	270	290	100	142.5	95	11	3-M16	400	1200	10-140	100-315
320A	270	290	100	155.5	95	11	3-M16	400	1200	10-140	100-315
325	272	296	100	142.5	96	11	3-M16	400	1200	10-140	100-315
325A	272	296	100	155.5	96	11	3-M16	400	1200	10-140	100-315
380	325	350	135	155.5	98	6	3-M16	500	1000	15-210	120-400
380A	325	350	135	170.5	98	6	3-M16	500	1000	15-210	120-400
400	340	368	130	155.5	100	6	3-M16	500	1000	15-210	120-400
400A	340	368	130	170.5	100	6	3-M16	500	1000	15-210	120-400
500	440	465	200	176	115	6	6-M16	500	1000	25-280	150-500
500A	440	465	200	203	115	6	6-M16	630	800	25-280	150-500
630A	560	595	260	218	130	8	6-M16	800	600	50-350	170-630
800A	710	760	280	249	155	8	6-M20	1000	730	150-640	250-800
1000A	910	950	400	266	165	10	6-M24	1200	600	260-720	450-1000

Tmax – максимальный крутящий момент

RPM – максимальное количество оборотов в минуту