

Опора шлицевого вала

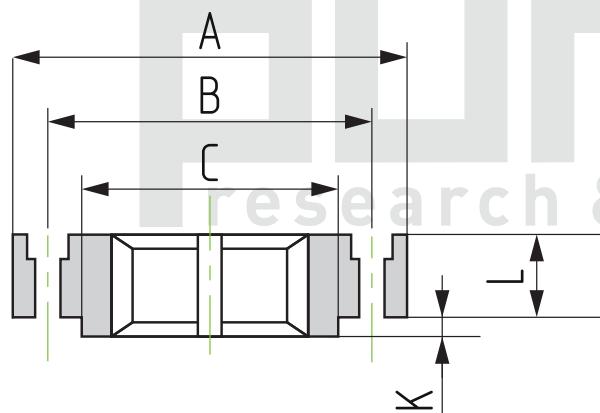
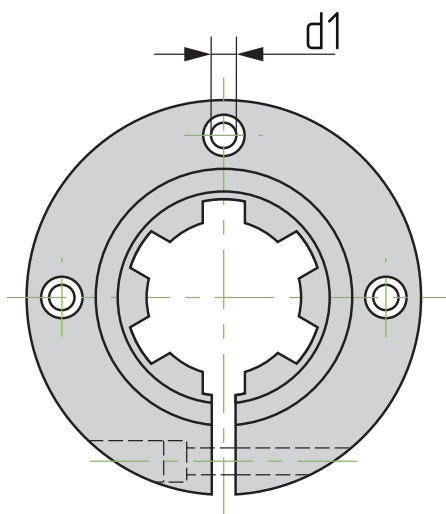

Артикул	A(mm)	B(mm)	d1(mm) H13	C(mm) H6	L(mm)	K(mm)
SH - 11x14	42	28	4.5	20.0	12	2
SH - 13x16	50	36	4.5	22.0	12	2
SH - 16x20	52	38	5.5	25.0	14	2
SH - 18x22	56	42	5.5	28.0	14	2
SH - 21x25	65	48	6.6	35.0	14	3
SH - 23x28	64	50	6.6	34.0	15	3
SH - 26x32	70	56	6.6	40.0	15	3
SH - 29x35	75	60	8	46.0	16	3
SH - 32x38	80	65	9	50.0	18	3
SH - 36x42	85	70	10	55.0	20	3
SH - 42x48	95	75	11	60.0	22	3