

Шпиндель GW0.8/220/24K-D65/ER11A

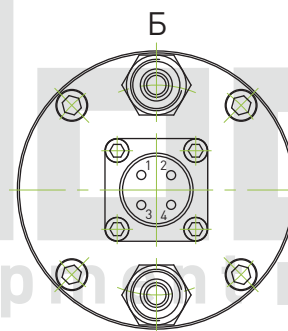

- 1 PE \perp
- 2 U
- 3 V
- 4 W

Шпиндель GW1.5/220/24K-D80

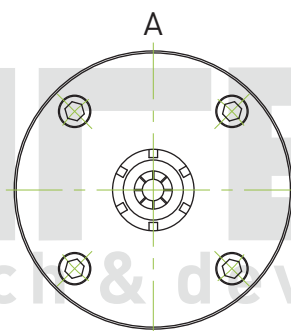
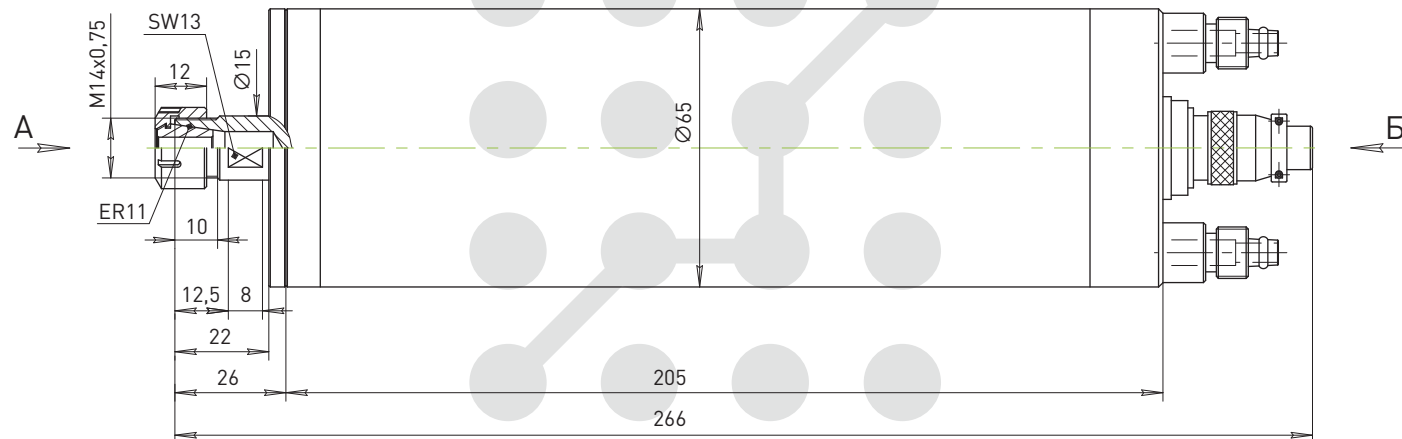
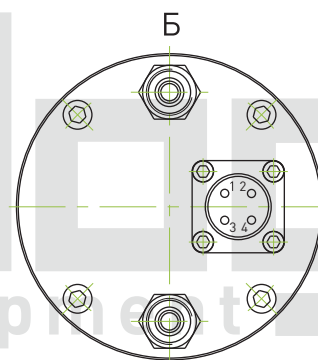
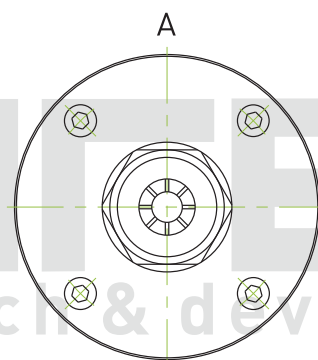
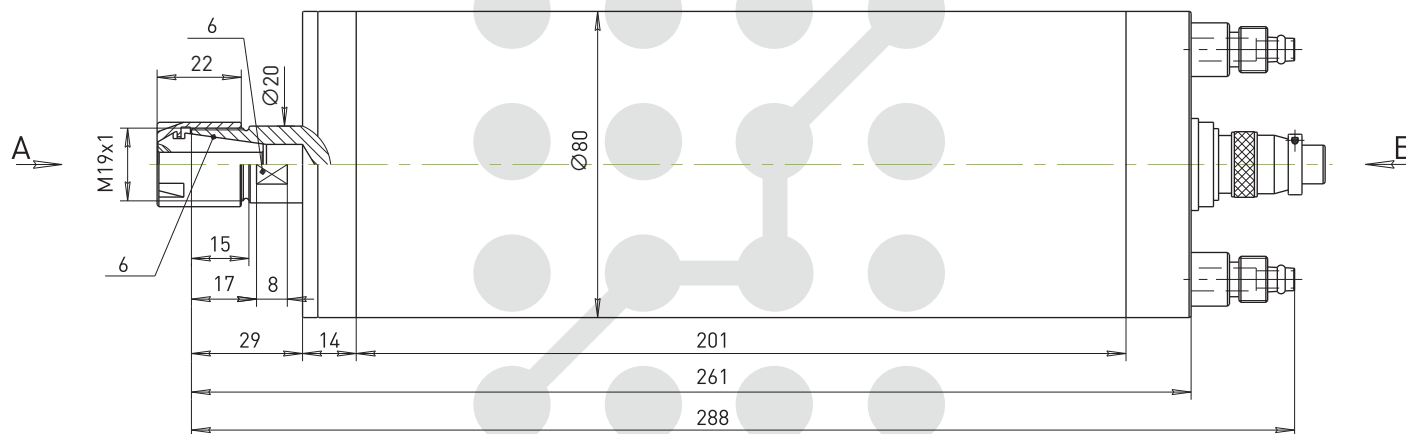

- 1 PE ⊥
- 2 U
- 3 V
- 4 W

Шпиндель GW2.2/220/24K-D80/ER20A

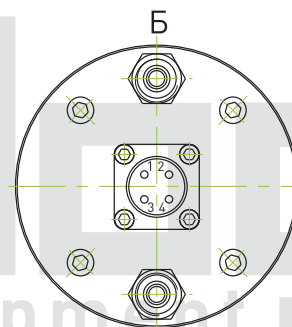
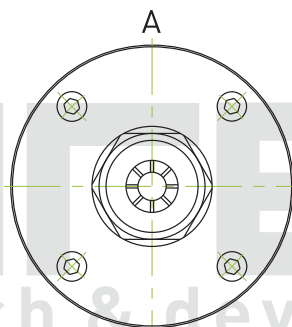
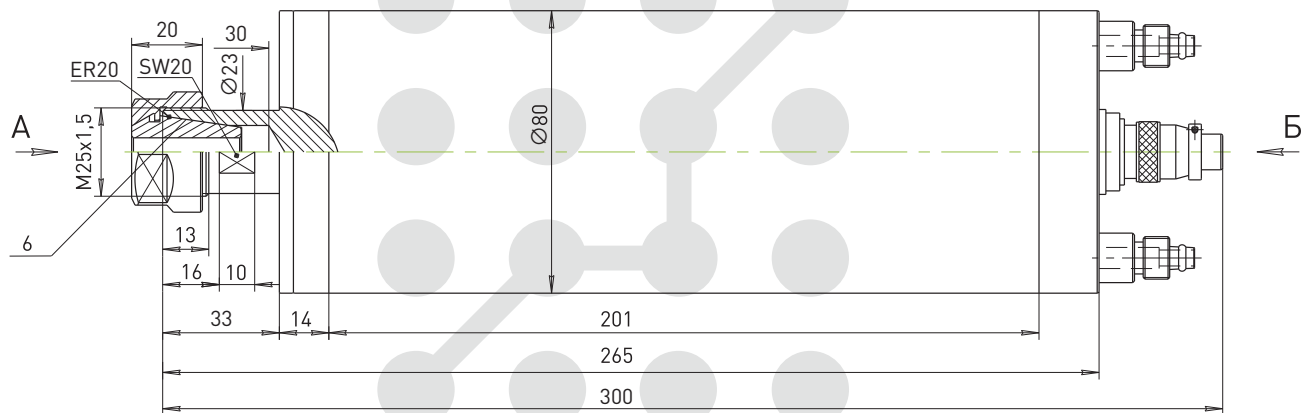

- 1 PE ⊥
- 2 U
- 3 V
- 4 W